

Varenummer: 20171B302SW
 Beskrivelse: E+G
 Bred hjørne holder GN171-B30-2-SW

Mål

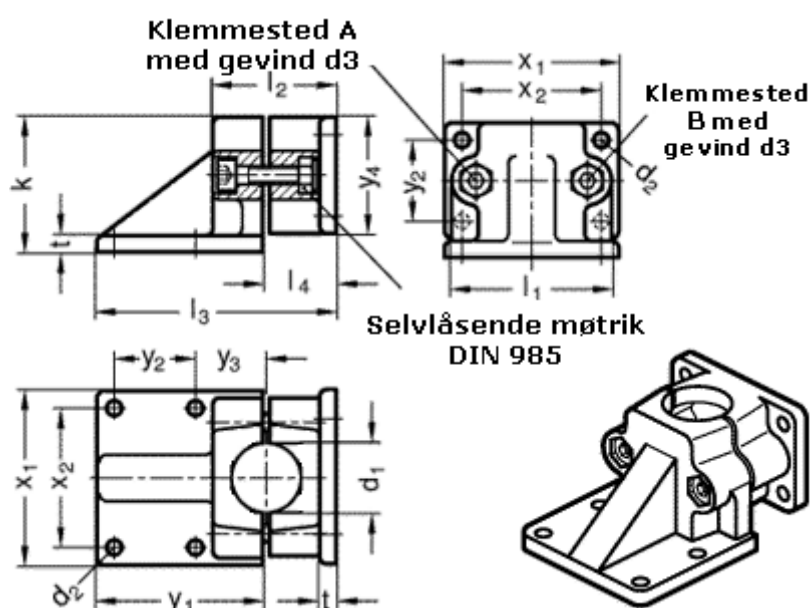

$d_1 = B30$	$t = 7$
$d_2 = 7$	$x_1 = 75$
$d_3 = M 8$	$x_2 = 60$
$k = 58$	$y_1 = 72$
$l_1 = 69$	$y_2 = 35$
$l_2 = 53$	$y_3 = 30$
$l_3 = 103$	$y_4 = 50$
$l_4 = 30$	